

CATALOGUE DE VENTES
SECTION - H -TIGES ACME
(ACME RODS)ÉCROUS ACME
(ACME NUTS)COUSSINETS
(BEARINGS)RIVETS CACHÉS
(BLIND RIVETS)BOULONS GRADE 5
(BOLTS GRADE 5)BOULONS FEDALLOY
(BOLTS FEDALLOY)BOULONS MÉTRIQUES
(BOLTS METRIC)BAGUE DE BRONZE
(BRONZE BUSHINGS)AXE DE CHAPE
(CLEVIS PINS)GOUILES FENDUES
(COTTER PINS)BOUCHON DE VIDANGE
(DRAIN PLUG)GOUJON DE MOTEUR
(ENGINE STUDS)BOUCHON D'EXPANSION
(FROST PLUGS)GOUPILLES
(TAPER PINS)RONDELLES D'AJUSTEMENT
(MACHINERY BUSHINGS)CLÉ EN LONGUEUR
(MAK-A-KEY)TIGE FILETÉE
(READY-ROD)GOUPILLES À RESSORT
(ROLL PINS)CLÉ DEMI-LUNE
(WOODRUFF KEY)COLLETS D'AJUSTEMENT
(SET COLLARS)VIS DE PRESSION À PANS CREUX
(SOCKET SCREWS)ANNEAU D'ARRÊT
(SNAP RINGS)TARAUD & FILIÈRES
(TAP & DIES)RONDELLES À TÊTE RONDE & PLATE
(WASHERS LOCK & FLAT)

BOULONS DE PRÉCISION HEXAGONAUX HEXAGONAUX HEAD CAP SCREWS

GRADE 5

FINI PLAQUÉ BRILLANT
BRIGHT PLATED FINISH

FEDALLOY

EXTRA-ROBUSTE
SUPER-STRENGTH

PRIX LE 100 - PRICE BY 100

		1/4 DIA. GRADE 5				1/4 DIA. FEDALLOY	
		UNC	UNF			UNC	UNF
Long Length	Boîte Box	Numéros Numbers	Numéros Numbers	Long Length	Boîte Box	Numéros Numbers	Numéros Numbers
1/2	100	170-405	175-405				
3/4	100	170-407	175-407				
1	100	170-410	175-410				
1-1/4	100	170-412	175-412				
1-1/2	100	170-415	175-415				
1-3/4	100	170-417	175-417				
2	100	170-420	175-420				
2-1/4	100	170-422	175-422				
2-1/2	100	170-425	175-425				
3	100	170-430	175-430				
3-1/2	100	170-435	175-435				
4	100	170-440	175-440				
4-1/2	100	170-445	175-445				
5	100	170-450	175-450				
		5/16 DIA. GRADE 5				5/16 DIA. FEDALLOY	
1/2	100		175-505				
3/4	100	170-507	175-507				
1	100	170-510	175-510				
1-1/4	100	170-512	175-512				
1-1/2	100	170-515	175-515				
1-3/4	100	170-517					
2	100	170-520	175-520				
2-1/2	100	170-525	175-525				
3	100	170-530	175-530				
3-1/2	100	170-535	175-535				
4	100	170-540	175-540				
4-1/2	100	170-545	175-545				
5	100	170-550	175-550				
6	100	170-560					

BOULONS DE PRÉCISION HEXAGONAUX HEXAGON HEAD CAP SCREWS

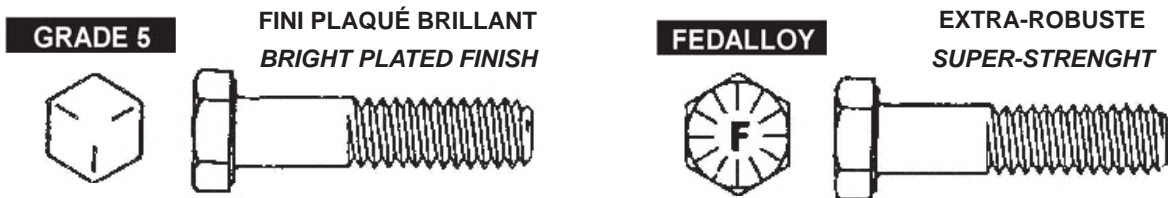

PRIX LE 100 - PRICE BY 100

		3/8 DIA. GRADE 5				3/8 DIA. FEDALLOY	
Long <i>Length</i>	Boîte <i>Box</i>	UNC	UNF	Long <i>Length</i>	Boîte <i>Box</i>	UNC	UNF
		Numéros <i>Numbers</i>	Numéros <i>Numbers</i>			Numéros <i>Numbers</i>	Numéros <i>Numbers</i>
1/2	100	170-605					
3/4	100	170-607	175-607				
1	100	170-610	175-610				
1-1/4	100	170-612	175-612				
1-1/2	100	170-615	175-615				
1-3/4	100	170-617					
2	100	170-620	175-620				
2-1/4	100	170-622					
2-1/2	100	170-625	175-625				
3	100	170-630	175-630				
3-1/2	100	170-635	175-635				
4	100	170-640	175-640				
4-1/2	100	170-645	175-645				
5	100	170-650	175-650				
5-1/2	50	170-655	175-655				
6	50	170-660	175-660				
		7/16 DIA. GRADE 5				7/16 DIA. FEDALLOY	
3/4	50		175-707				
1	50	170-710	175-710				
1-1/4	50	170-712	175-712				
1-1/2	50	170-715	175-715				
1-3/4	50	170-717	175-717				
2	50	170-720	175-720				
2-1/4	50	170-722					
2-1/2	50	170-725	175-725				
2-3/4	50	170-727					
3	50	170-730					
3-1/2	50	170-735	175-735				
4	50	170-740	175-740				
4-1/2	50	170-745	175-745				
5	50	170-750	175-750				
5-1/2	50	170-755	175-755				
6	50						

**BOULONS DE PRÉCISION HEXAGONAUX
HEXAGONAUX HEAD CAP SCREWS**

GRADE 5

FINI PLAQUÉ BRILLANT
BRIGHT PLATED FINISH

FEDALLOY

EXTRA-ROBUSTE
SUPER-STRENGTH

PRIX LE 100 - PRICE BY 100

		1/2 DIA. GRADE 5				1/2 DIA. FEDALLOY	
		UNC	UNF			UNC	UNF
Long Length	Boîte Box	Numéros Numbers	Numéros Numbers	Long Length	Boîte Box	Numéros Numbers	Numéros Numbers
1	50	170-810	175-810				
1-1/4	50	170-812	175-812				
1-1/2	50	170-815	175-815				
2	50	170-820	175-820				
2-1/2	50	170-825	175-825				
3	50	170-830	175-830				
3-1/2	50	170-835	175-835				
4	50	170-840	175-840				
4-1/2	50	170-845	175-845				
5	50	170-850					
5-1/2	50		175-855				
6	25	170-860	175-860				
6-1/2	25	170-865	175-865				
		9/16 DIA. GRADE 5				9/16 DIA. FEDALLOY	
1	25		175-912				
1-1/4	25						
1-1/2	25	170-915					
2	25	170-920	175-920				
2-1/4	25		175-922				
2-1/2	25	170-925	175-925				
3	25	170-930	175-930				
3-1/2	25	170-935					
4	25	170-940					
4-1/2	25	170-945					
5	25	170-950					

BOULONS DE PRÉCISION HEXAGONAUX HEXAGON HEAD CAP SCREWS

GRADE 5

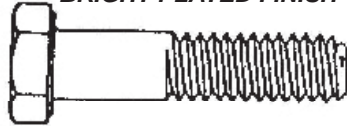
 FINI PLAQUÉ BRILLANT
BRIGHT PLATED FINISH

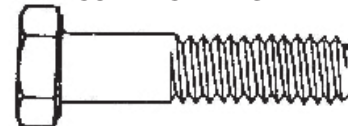
FEDALLOY

 EXTRA-ROBUSTE
SUPER-STRENGTH

		5/8 DIA. GRADE 5				5/8 DIA. FEDALLOY	
		PRIX LE 100 - PRICE BY 100					
		UNC	UNF			UNC	UNF
Long Length	Boîte Box	Numéros Numbers	Numéros Numbers	Long Length	Boîte Box	Numéros Numbers	Numéros Numbers
1	25	170-1010	175-1010				
1-1/4	25	170-1012					
1-1/2	25	170-1015	175-1015				
1-3/4	25	170-1017					
2	25	170-1020	175-1020				
2-1/2	25	170-1025	175-1025				
2-3/4	25	170-1027					
3	25	170-1030	175-1030				
3-1/2	25	170-1035	175-1035				
4	25	170-1040	175-1040				
4-1/2	25	170-1045	175-1045				
5	25	170-1050	175-1050				
5-1/2	25	170-1055	175-1055				
6	25	170-1060	175-1060				
7	25		175-1070				
7-1/2	25		175-1075				
9	"Bulk"		175-1090				
10	"Bulk"		175-10100				
11	"Bulk"	170-10110	175-10110				
12	"Bulk"	170-10120	175-10120				
		3/4 DIA. GRADE 5				3/4 DIA. FEDALLOY	
1-1/4	20	170-1212	175-1212				
1-1/2	20	170-1215	175-1215				
2	20	170-1220	175-1220				
2-1/2	20	170-1225	175-1225				
3	20	170-1230	175-1230				
3-1/2	20	170-1235	175-1235				
4	20	170-1240	175-1240				
4-1/2	20	170-1245					
5	20	170-1250	175-1250				
5-1/2	20	170-1255	175-1255				
6	20	170-1260	175-1260				
7-1/2	20		175-1275				

**BOULONS DE PRÉCISION HEXAGONAUX
HEXAGONAUX HEAD CAP SCREWS**



**FINI PLAQUÉ BRILLANT
BRIGHT PLATED FINISH**

PRIX LE 100 - PRICE BY 100

7/8 DIA. GRADE 5 UNC			1" DIA. GRADE 5 UNC		
Long Length	Boîte Box	Numéros Numbers	Long Length	Boîte Box	Numéros Numbers
2	20	170-1420			
2-1/2	20	170-1425	2-1/2	20	170-1625
3	20	170-1430	3	20	170-1630
3-1/2	20	170-1435	3-1/2	10	170-1635
4	20	170-1440	4	10	170-1640
4-1/2	20	170-1445	4-1/2	10	170-1645
5	20	170-1450	5	10	170-1650
5-1/2	10	170-1455	5-1/2	10	170-1655
6	10	170-1460	6	10	170-1660
			6-1/2	10	170-1665
			7	10	170-1670
			7-1/2	10	170-1675

**Boulons de carrosserie
Carriage bolts**

Gros filet UNC / Coarse thread UNC

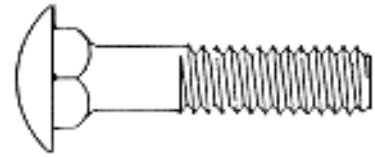

PRIX LE 100 / PRICE BY 100

LONGUEUR LENGTH	1/4 DIA.		LONGUEUR LENGTH	5/16 DIA.	
	BOÎTE BOX	UNC		BOÎTE BOX	UNC
		NUMÉROS NUMBERS			NUMÉROS NUMBERS
3/4	100	CB407	3/4	100	CB507
1	100	CB410	1	100	CB510
1-1/2	100	CB415	1-1/2	100	CB515
2	100	CB420	2	100	CB520
2-1/2	100	CB425	2-1/2	100	CB525
3	100	CB430	3	100	CB530
3-1/2	100	CB435	3-1/2	100	CB535
4	100	CB440	4	100	CB540
4-1/2	100	CB445			
5	100	CB450	5	100	CB550
	3/8 DIA.			7/16 DIA.	
	BOÎTE BOX	UNC		BOÎTE BOX	UNC
		NUMÉROS NUMBERS			NUMÉROS NUMBERS
1	100	CB610	1-1/2	50	CB715
1-1/2	100	CB615			
2	100	CB620			
2-1/2	100	CB625			
3	100	CB630			
3-1/2	100	CB635			
4	100	CB640			
5	50	CB650	4-1/2	50	CB745
6	50	CB660	5	50	CB750
			6	50	CB760
	1/2 DIA.				
	BOÎTE BOX	UNC			
		NUMÉROS NUMBERS			
1-1/2	50	CB815			
2	50	CB820			
2-1/2	50	CB825			
3	50	CB830			
3-1/2	50	CB835			

Boulons de précision hexagonaux, métriques gros-filets Hexagon head cap screws, metric coarse thread

4 mm - DIA PITCH 0.70		
Long Length	Boîte Box	Numéros Numbers
10 mm	100	190-410
16 mm	100	190-416
20 mm	100	190-420
25 mm	100	190-425

5 mm - DIA PITCH 0.80		
Long Length	Boîte Box	Numéros Numbers
12mm	100	190-512
16mm	100	190-516
20mm	100	190-520
25mm	100	190-525
30mm	100	190-530
35mm	100	190-535

6 mm - DIA PITCH 1.00			8 mm - DIA PITCH 1.25		10 mm - DIA PITCH 1.50		12 mm - DIA PITCH 1.75	
Long Length	Boîte Box	Numéros Numbers	Boîte Box	Numéros Numbers	Boîte Box	Numéros Numbers	Boîte Box	Numéros Numbers
10 mm	100	190-610	100	190-810				
12 mm	100	190-612	100	190-812				
16 mm	100	190-616	100	190-816	100	190-1016		
20 mm	100	190-620	100	190-820	100	190-1020	50	190-1220
25 mm	100	190-625	100	190-825	100	190-1025	50	190-1225
30 mm	100	190-630	100	190-830	100	190-1030	50	190-1230
35 mm	100	190-635	100	190-835	100	190-1035	50	190-1235
40 mm	100	190-640	100	190-840	100	190-1040	50	190-1240
45 mm	100	190-645	100	190-845	100	190-1045	50	190-1245
50 mm	100	190-650	100	190-850	100	190-1050	50	190-1250
60 mm	10	190-660	100	190-860	100	190-1060	50	190-1260
65 mm							50	190-1265
70 mm	10	190-670	100	190-870	100	190-1070	50	190-1270
75 mm					100	190-1075	50	190-1275
80 mm	10	190-680	100	190-880	100	190-1080	50	190-1280
90 mm					100	190-1090		
100mm					100	190-10100	50	190-1290
110mm					100	190-10110		
120mm					100	190-10120		
14 mm - DIA PITCH 2.00			16 mm - DIA PITCH 2.00		18 mm - DIA PITCH 2.50		20 mm - DIA PITCH 2.50	
20 mm	25	190-1420						
25 mm	25	190-1425	25	190-1625				
30 mm	25	190-1430	25	190-1630				
35 mm	25	190-1435	25	190-1635				
40 mm	25	190-1440	25	190-1640	25	190-1840	25	190-2040
			25	190-1645			25	190-2045
50 mm	25	190-1450	25	190-1650	25	190-1850	25	190-2050
							25	190-2055
60 mm	25	190-1460	25	190-1660	25	190-1860	25	190-2060
			25	190-1665				
70 mm	25	190-1470	25	190-1670	25	190-1870	25	190-2070
75 mm			25	190-1675			25	190-2075
80 mm	25	190-1480	25	190-1680	25	190-1880	25	190-2080
90 mm	25	190-1490	25	190-1690	25	190-1890	25	190-2090
100 mm	25	190-14100	25	190-16100	25	190-18100	25	190-20100
120mm							25	190-20120
140 mm			25	190-16140			25	190-20140

Boulons de précision hexagonaux, métriques, filets unis
Hexagon head cap screws, metric, fine thread

Plaqué / Plated

LONG LENGTH	8 mm - DIA Pitch 1.00		10 mm - DIA Pitch 1.00		10 mm - DIA Pitch 1.25	
	BTE BOX	NUMÉROS NUMBERS	BTE BOX	NUMÉROS NUMBERS	BTE BOX	NUMÉROS NUMBERS
20 mm	50	195-820	25	195-1020100	25	195-1020
25 mm			25	195-1025100	25	195-1025
30 mm	50	195-830	25	195-1030100	25	195-1030
35 mm					25	195-1035
40 mm	50	195-840	25	195-1040100	25	195-1040
50 mm	50	195-850	25	195-1050100	25	195-1050
60 mm			25	195-1060100	25	195-1060
70 mm					25	195-1070
80 mm					25	195-1080
90 mm					25	195-1090
100 mm					25	195-10100

LONG LENGTH	12 mm - DIA Pitch 1.25		12 mm - DIA Pitch 1.50		14 mm - DIA Pitch 1.50	
	BTE BOX	NUMÉROS NUMBERS	BTE BOX	NUMÉROS NUMBERS	BTE BOX	NUMÉROS NUMBERS
25 mm			25	195-1225	25	195-1425
30 mm	25	195-1230125	25	195-1230	25	195-1430
40 mm	25	195-1240125	25	195-1240	25	195-1440
45 mm			25	195-1245		
50 mm	25	195-1250125	25	195-1250	25	195-1450
55 mm			25	195-1255		
60 mm	25	195-1260125	25	195-1260	25	195-1460
70 mm	25	195-1270125	25	195-1270	25	195-1470
80 mm	10	195-1280125	25	195-1280	25	195-1480
90 mm			25	195-1290	25	195-1490
100 mm			25	195-12100	10	195-14100
120 mm			10	195-12120		
140 mm					10	195-14140

Boulons de précision hexagonaux, métriques, filets unis
Hexagon head cap screws, metric, fine thread

Plaqué / Plated

	16 mm - DIA Pitch 1.50		18 mm - DIA Pitch 1.50		20 mm - DIA Pitch 1.50	
LONG LENGTH	BTE BOX	NUMÉROS NUMBERS	BTE BOX	NUMÉROS NUMBERS	BTE BOX	NUMÉROS NUMBERS
25 mm	25	195-1625				
30 mm	25	195-1630				
40 mm	25	195-1640	25	195-1840	10	195-2040
50 mm	25	195-1650	25	195-1850	10	195-2050
60 mm	25	195-1660	25	195-1860	10	195-2060
70 mm	25	195-1670	25	195-1870	10	195-2070
80 mm	25	195-1680	25	195-1880	10	195-2080
90 mm	25	195-1690	25	195-1890	10	195-2090
100 mm	25	195-16100	10	195-18100	10	195-20100
110 mm	25	195-16110			10	195-20110
120 mm	10	195-16120	10	195-18120	10	195-20120
130 mm	10	195-16130	10	195-18130		
140 mm	10	195-16140			10	195-20140
150 mm			10	195-18150		

Écrous hexagonaux métriques,
filets fins, plaqué.
*Hexagon nuts metric,
fine thread, plated*

Écrous de blocage métriques (nylon),
filets fins, plaqué.
*Self locking nuts (nylon insert)
fine thread, plated*

	BTE BOX	NUMÉROS NUMBERS		BTE BOX	NUMÉROS NUMBERS
M8x1.0	25	NUM8100	M8x1.0	100	NILN8100
M10x1.0	25	NUM10100	M10x1.0	100	NILN10100
M10x1.25	25	NUM10125	M10x1.25	50	NILN10125
M12x1.0	25	NUM12100	M12x1.25	50	NILN12125
M12x1.25	25	NUM12125	M12x1.50	50	NILN12150
M12x1.50	25	NUM12150	M14x1.5	10	NILN14150
M14x1.5	25	NUM14150	M16x1.5	10	NILN16150
M16x1.5	25	NUM16150	M18x1.5	10	NILN18150
M18x1.5	25	NUM18150	M20x1.5	10	NILN20150
M20x1.5	25	NUM20150			
M22x1.5	10	NUM22150			
M24x1.5	10	NUM24150			



022-091 DIMENSIONS:
 15 1/4" Largeur / width
 15-1/2" hauteur / height
 11-3/4" profondeur / deep

Numéros Numbers	Description
022-091	Cabinet acier sans tiroirs cap: 6 <i>Steel cabinet without trays cap: 6</i>
022-092	Tiroir de métal vide 20 compartiments <i>Metal tray empty 20 compartments</i>
022-093	Cabinet acier sans tiroirs cap: 4 <i>Steel cabinet without trays cap: 4</i> Dimensions: 20" largeur x 14-1/2" hauteur x 15-3/4" profondeur
022-094	Tiroir métal vide 32 compartiments <i>Metal tray empty 32 compartments.</i>

ASSORTIMENT DE BOULONS MÉTRIQUES ASSORTMENT CAP SCREWS METRIC



No. MF101 (020-725)

Contient : 255 Boulons - 255 Écrous - 60 contre-écrous
 Content: 255 Cap Screws - 255 Nuts - 60 lock nuts

M4x16	M6x16	M4 Écrous hexagonaux / Hex nuts
M5x12	M6x20	M5
M5x16	M6x25	M6
M5x20	M6x30	M4 Contre-écrou / Lock nut
M5x25	M6x35	M5
M6x12	M6x45	M6

No. MF102 (020-726)

Contient : 83 Boulons - 83 Écrous - 20 contre-écrous
 Content: 83 Cap Screws - 83 Nuts - 20 lock nuts

M8x12	M8x50	M10x60
M8x16	M6x60	M10x70
M8x20	M8x70	M8 Écrous hexagonaux / Hex nuts
M8x25	M10x30	M10
M8x30	M10x40	M8 Contre-écrou / Lock nuts
M8x40	M10x50	M10



ASSORTIMENT VIS TARAUDEUSES " TAPPING SCREWS "

SHEET METAL SCREWS - SLOT HEAD - BRIGHT PLATED

No. SMS8 (020-612)

Boîte en métal

Contient 937 morceaux en 18 grandeurs différentes:

Pan 6x 3/8, 1/2, 3/4, 1", - 8x3/8, 1/2, 3/4, 1", - 10x1/2, 3/4, 1", - 14x 1".

Oval 6x3/4, 1", - 10x3/4.

Hex 8x1/2, - 10x3/4, - 14x1".



VIS DE MÉCANIQUE / MACHINE SCREWS

SDMS32 (020-624)

Contient 560 boulons 560 écrous avec tête plate ronde et des écrous hexagonaux. Boîte métallique. Poignée de sécurité . Remplacement disponible en paquet de 100.

Content 560 screws, 560 nuts with round and flat head and hexagon nuts. Metal box. Safety snap carrying handle. Refills available in package of 100.

Round 6-32x3/8, 1/2, 1", 1-1/2. 8-32x1/2, 3/4, 1", 1-1/2. 10-32x1/2, 1", 1-1/2, 1/4-20x3/4, 1", 1-1/4.

Oval 6-32x3/8, 1/2, 1". 8-32x1/2, 3/4, 8-32x1", 1-1/2, 10-32x1/2, 1", 1-1/2, 1/4-20x1".

Nuts 6-32, 8-32, 10-32, 10-24, 1/4-20.



SPW18

**BROCHE DE MÉCANICIEN
" STOVE PIPE WIRE "**

Cette broche est très malléable et utile pour usage de garage et d'atelier. Utilisée pour barrer les boulons troués de roulements à billes et des flywheels, rouleau de 2 livres, 330 pieds, 18ga. (.047")

Soft annealed for general repair work in garage, industry and home workshop.

Fond des compartiments arrondis
Couvercle moulé avec la base évitant le mélange des pièces
Longueurs et grosseurs gravés sur le couvercle
Plastique résistant et robuste

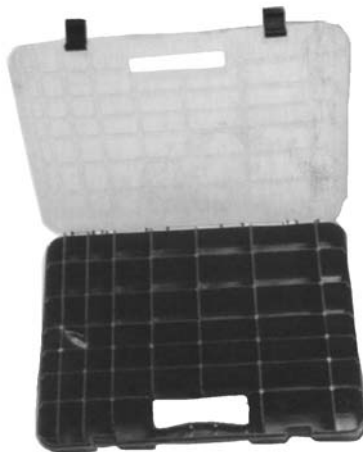

021-599

Coffret vide 55 compartiments - plastique noir
Empty parts storage - box black plastic

021-605

Assortiment de 525 vis à bois, coffre bleu (42 grandeurs)
tête plate & tête ronde # 10 de 3/4" à 3" long/length
flat and round head # 8 de 1/2 à 3" long/length
6 de 1/2" à 2" long/length
Wood screw assortment blue case (42 sizes)

021-610

Assortiment de 525 boulons, écrous, rondelles
coffre rouge (48 grandeurs)
Assortment bolt, nut, washer red case (48 sizes)

	3/8" x 10	5/16" x 10	1/4" x 25	10/24 x 25	8/32 x 15	6/32 x 15
	3/8" x 10	5/16" x 10	1/4" x 20	10/24 x 20	8/32 x 15	6/32 x 15
	3/8" x 10	5/16" x 10	1/4" x 30	10/24 x 30	8/32 x 20	6/32 x 20
	3/8-1x4	3/8-1-1/2x4	3/8-2x4	3/8-2-1/2x3	3/8-3x2	
	5/16-1x7	5/16-1-1/2x7	5/16-2x5	5/16-2-1/2x3	5/16-3x2	
	1/4-1x7	1/4-1-1/2x7	1/4-2x5	1/4-2-1/2x3	1/4-3x2	
	10/24-1/2x10	10/24-3/4x15	10/24-1x15	10/24-1-1/2x5	10/24-2x5	
	8/32-1/2x10	8/32-3/4x15	8/32-1x15	8/32-1-1/2x5	8/32-2x5	
	6/32-1/2x10	6/32-3/4x15	6/32-1x15	6/32-1-1/2x5	6/32-2x5	

*Coin-bottom compartment for easy access
Sealed cover molded with the base to prevent part mix-up
Lengths and sizes embossed on the cover
Temperature resistant nylon*

**Vis taraudeuses
Tapping and sheet metal screws**

Tête hex Hex head		Tête Pan Pan head		Tête Truss Truss head		Tête Ovale Oval head	
Numéros Numbers	Description	Numéros Numbers	Description	Numéros Numbers	Description	Numéros Numbers	Description
HT0606	# 6 x 3/8"	PT0404	# 4 x 1/4"	TT0606	# 6 x 3/8"	OT0612	# 6 x 3/4"
HT0808	# 8 x 1/2"	PT0406	# 4 x 3/8"	TT0608	# 6 x 1/2"	OT0616	# 6 x 1"
HT0812	# 8 x 3/4"	PT0408	# 4 x 1/2"	TT0610	# 6 x 5/8"	OT0812	# 8 x 3/4"
HT0816	# 8 x 1"	PT0412	# 4 x 3/4"	TT0612	# 6 x 3/4"	OT0816	# 8 x 1"
HT0820	# 8 x 1-1/4"	PT0416	# 4 x 1"	TT0616	# 6 x 1"	OT1012	# 10 x 3/4"
HT0824	# 8 x 1-1/2"	PT0604	# 6 x 1/4"	TT0806	# 8 x 3/8"		
HT1006	# 10 x 3/8"	PT0606	# 6 x 3/8"	TT0808	# 8 x 1/2"		
HT1008	# 10 x 1/2"	PT0608	# 6 x 1/2"	TT0810	# 8 x 5/8"		
HT1010	# 10 x 5/8"	PT0610	# 6 x 5/8"	TT0812	# 8 x 3/4"		
HT1012	# 10 x 3/4"	PT0612	# 6 x 3/4"	TT0816	# 8 x 1"		
HT1016	# 10 x 1"	PT0616	# 6 x 1"	TT0824	# 8 x 1-1/2"		
HT1208	# 12 x 1/2"	PT0620	# 6 x 1-1/4"	TT1008	# 10 x 1/2"		
HT1212	# 12 x 3/4"	PT0624	# 6 x 1-1/2"	TT1012	# 10 x 3/4"		
HT1216	# 12 x 1"	PT0806	# 8 x 3/8"	TT1016	# 10 x 1"		
HT1408	# 14 x 1/2"	PT0808	# 8 x 1/2"	TT1020	# 10 x 1-1/4"		
HT1410	# 14 x 5/8"	PT0810	# 8 x 5/8"				
HT1412	# 14 x 3/4"	PT0812	# 8 x 3/4"				
HT1416	# 14 x 1"	PT0816	# 8 x 1"				
HT1420	# 14 x 1-1/4"	PT0820	# 8 x 1-1/4"				
HT1424	# 14 x 1-1/2"	PT0824	# 8 x 1-1/2"				
HT51612	5/16" x 3/4"	PT0832	# 8 x 2"				
HT51616	5/16" x 1"	PT1006	# 10 x 3/8"				
HT51620	5/16" x 1-1/4"	PT1008	# 10 x 1/2"				
HT51624	5/16" x 1-1/2"	PT1010	# 10 x 5/8"				
HT3816	3/8" x 1"	PT1012	# 10 x 3/4"				
HT3824	3/8" x 1-1/2"	PT1016	# 10 x 1"				
		PT1020	# 10 x 1-1/4"				
		PT1024	# 10 x 1-1/2"				
		PT1032	# 10 x 2"				
		PT1208	# 12 x 1/2"				
		PT1212	# 12 x 3/4"				
		PT1216	# 12 x 1"				
		PT1220	# 12 x 1-1/4"				
		PT1224	# 12 x 1-1/2"				
		PT1232	# 12 x 2"				
		PT1410	# 14 x 5/8"				
		PT1412	# 14 x 3/4"				
		PT1416	# 14 x 1"				
		PT1420	# 14 x 1-1/4"				
		PT1424	# 14 x 1-1/2"				
		PT1432	# 14 x 2"				

Amortisseurs de vibration - *Anti-vibration mounts*

Type mâle / mâle - *Bolt to bolt type*

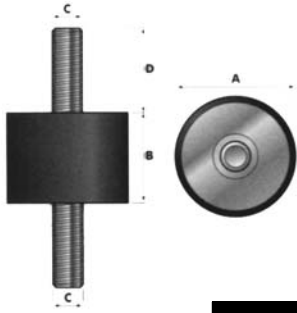

Usage universel - *For multi-purpose.*

- Matériel: Caoutchouc naturel
Material: Natural rubber
- Dureté: 55° (+/-5%)
Approx: 57 duromètre
Shore hardness: 55° (+/-5%).
Approx: 57 durometer

Numéros Numbers	Largeur Width A mm	Profondeur Depth B mm	Filets Thread C	Longueur du boulon Screw Length D mm
S55400	15	15	M4	12
S55402	20	15	M6	15
S55403	20	20	M6	15
S55405	25	20	M6	18
S55406	25	30	M6	18
S55407	30	15	M8	20
S55408	30	20	M8	20
S55409	30	30	M8	20
S55410	40	30	M8	23
S55411	40	40	M8	23
S55414	50	40	M10	28
S55418	60	40	M10	28

Type femelle / femelle - *Taper to taper type*



Usage universel - *For multi-purpose.*

- Matériel: Caoutchouc naturel
Material: Natural rubber
- Dureté: 55° (+/-5%)
Approx: 57 duromètre
Shore hardness: 55° (+/-5%).
Approx: 57 durometer

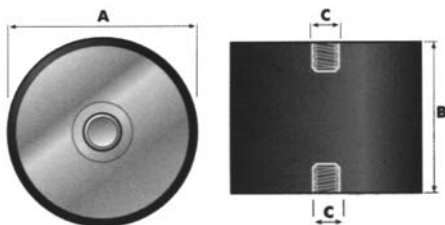

Numéros Numbers	Largeur Width A mm	Profondeur Depth B mm	Filets Thread C
S55451	25	20	M6
S55452	30	30	M8
S55453	40	30	M8
S55454	40	40	M8
S55455	50	30	M10
S55456	50	40	M10
S55457	50	45	M10

Écrous hexagonaux, fini plaqué, extra robustes Finished hexagon nuts plated, super-strength, fedalloy



DIA.	BTE BOX	UNC	UNF	DIA.	BTE BOX	UNC	UNF
		NUMÉROS NUMBERS	NUMÉROS NUMBERS			NUMÉROS NUMBERS	NUMÉROS NUMBERS
1/4	100	NUR101	NUR201				
5/16	100	NUR102	NUR202				
3/8	100	NUR103	NUR203				
7/16	50	NUR104	NUR204				
1/2	50	NUR105	NUR205				
9/16	25	NUR106	NUR206				
5/8	25	NUR107	NUR207				
3/4	20	NUR108	NUR208				
7/8	20	NUR109	NUR209				
1	20	NUR110	NUR210				
1-1/8	15	NUR111	NUR211				
1-1/4	15	NUR112	NUR212				
1-1/2	10	NUR113	NUR213				

Écrous hexagonaux métriques, série gros filets Hexagon nuts metric, coarse thread series

Écrou de blocage nylon Nylon insert lock nuts

PLAQUÉ

UNC

UNF

3 mm	100	NUM3	M3x0.5				
4 mm	100	NUM4	M4x0.7				
5 mm	100	NUM5	M5x0.8	6-32	100	NILN101	
6 mm	100	NUM6	M6x1.00	8-32	100	NILN102	
7 mm	100	NUM7	M7x1.00				
8 mm	100	NUM8	M8x1.25	10-24	100	NILN103	NILN203
10 mm	100	NUM10	M10x1.50	10-32	100		
12 mm	50	NUM12	M12x1.75				
14 mm	25	NUM14	M14x2.00	1/4	100	NILN106	NILN206
16 mm	25	NUM16	M16x2.00	5/16	100	NILN107	NILN207
18 mm	25	NUM18	M18x2.50	3/8	100	NILN108	NILN208
20 mm	25	NUM20	M20x2.50	7/16	50	NILN109	NILN209
ÉCROU DE BLOCAGE NYLON NYLON INSERT LOCK NUTS				1/2	50	NILN110	NILN210
				9/16	25	NILN111	NILN211
				5/8	25	NILN112	NILN212
				3/4	20	NILN113	NILN213
				7/8	20	NILN114	NILN214
				1	20	NILN115	NILN215
				1-1/8	15	NILN116	NILN216
				1-1/4	15		NILN217
				1-1/2	10		NILN219
4 mm	100	NILN4	M4x0.7				
5 mm	100	NILN5	M5x0.8				
6 mm	100	NILN6	M6x1.0				
8 mm	100	NILN8	M8x1.25				
10 mm	100	NILN10	M10x1.50				
12 mm	50	NILN12	M12x1.75				
14 mm	50	NILN14	M14x2.00				
16 mm	25	NILN16	M16x2.00				
18 mm	10	NILN18	M18x2.50				
20 mm	10	NILN20	M20x2.50				

Écrous à oreilles, plaque brillante wing nuts, cadmium plated



DIA	BTE BOX	MÉTRIQUE - GROS			
		UNC		COARSE	
		NUMÉROS NUMBERS	DIA	BTE BOX	NUMÉROS NUMBERS
10-24	50	WN101	5 mm	10	WNM5
1/4	50	WN102	6 mm	10	WNM6
5/16	50	WN103	8 mm	10	WNM8
3/8	50	WN104	10 mm	10	WNM10
7/16	50	WN105	12 mm	10	WNM12
1/2	50	WN106			

Numéros Numbers	Description
920-610	Mandrin pour écrous à oreilles <i>Wing nut driver</i>

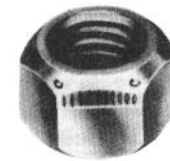

TRI-LOK® LOCK NUTS

*Regular ISO Coarse Thread Series
All metal for high temperature applications.*

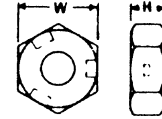

NUMÉROS NUMBERS	GRANDEUR SIZE	WIDTH A.F. (W)	HEIGHT (H)	STD Pkg
NTL6	M6	10	5.0	100
NTL8	M8	13	6.5	100
NTL10	M10	17	8.0	100
NTL12	M12	19	10.0	100
NTL14	M14	22	14	100

Écrou stover - Stover locknut

Dia	Bte Box	UNC Numéros Numbers
1/4	100	NTL101
5/16	100	NTL102
3/8	100	NTL103
7/16	50	NTL104
1/2	50	NTL105
9/16	25	NTL106
5/8	25	NTL107
3/4	20	NTL108
7/8	20	NTL109
1	20	NTL110

Rondelles à ressort ordinaires plaquées Medium spring lock washer plated



★ MÉTAL NU / BARE METAL

Rondelles plates, ordinaires plaquées Plain steel washers plated

★ MÉTAL NU / BARE METAL

EMPAQUETÉ À LA LIVRE / PACKED BY ONE POUND

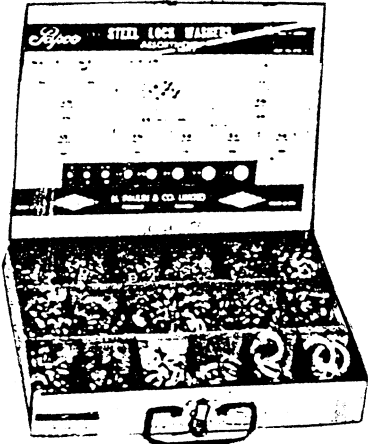
POUR "BOLTS"	QTÉ / QTY BOÎTE / BOX	NUMÉROS NUMBERS	POUR "BOLTS"	NUMÉROS NUMBERS	QTÉ / QTY 1 LBS
10	100	LW101			
1/4	100	LW102	1/4	WA102	APPROX. 160
5/16	100	LW103	5/16	WA103	APPROX. 95
3/8	100	LW104	3/8	WA104	APPROX. 74
7/16	100	LW105	7/16	WA105	APPROX. 38
1/2	100	LW106	1/2	WA106	APPROX. 25
9/16	100	LW106A	9/16	WA107	APPROX. 20
5/8	100	LW107	5/8	WA108	APPROX. 12
3/4	100	LW108	3/4	WA109	APPROX. 10
7/8	100	LW109	7/8	WA110	APPROX. 7
1	100	LW110	1	WA111	APPROX. 6
1-1/8	100	LW111 ★	1-1/8	WA112 ★	APPROX. 5
1-1/4	100	LW112 ★	1-1/4	WA113 ★	APPROX. 4
			1-1/2	WA114 ★	APPROX. 3

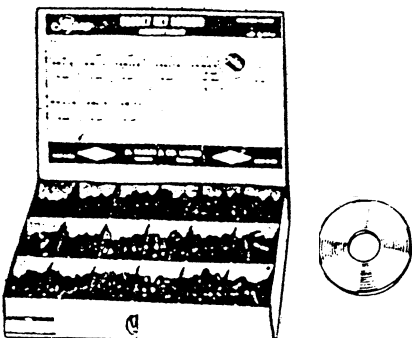
ILLUSTRATIONS	NUMÉROS NUMBERS	DESCRIPTION
	<p>MM17 (020-621)</p>	<p>Assortiment de rondelles à ressort Lock washer assortment</p>  <p>Assortiment comprenant 1257 rondelles à ressort de 1/8" à 7/8".</p> <p><i>Lock washer assortment (1257 pcs)</i></p>
	<p>MM16 (020-620)</p>	<p>Assortiment de rondelles plates ordinaires (1615 pièces)</p> <p><i>Plain washer assortment (1615 pieces)</i></p>

Rondelles plates, ordinaires plaquées
Plain steel washers plated

Rondelles à ressort, ordinaires plaquées
Medium spring lock washers plated

**FLAT
WASHERS**



**LOCK
WASHERS**

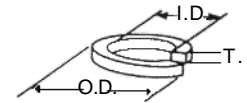

Numéros Numbers	Bolt size	I.D.	O.D.	(T) Thick.	Std. Pkg.
WA004	4mm	4.3	9.0	0.8	100
WA005	5mm	5.3	11.0	1.0	100
WA006	6mm	6.4	12.5	1.6	100
WA008	8mm	8.4	17.0	1.6	100
WA010	10mm	10.5	21.0	2.0	100
WA012	12mm	13.0	24.0	2.5	50
WA014	14mm	15.0	28.0	2.5	25
WA016	16mm	17.0	30.0	3.0	25
WA018	18mm	19.0	34.0	3.0	25
WA020	20mm	21.0	37.0	3.0	25
WA024	24mm	25.0	44.0	4.0	25

Numéros Numbers	Bolt size	I.D.	O.D.	(T) Thick.	Std. Pkg.
LW004	4mm	4.1	7.1	0.9	100
LW005	5mm	5.1	8.7	1.2	100
LW006	6mm	6.1	11.1	1.6	100
LW008	8mm	8.2	14.2	2.0	100
LW010	10mm	10.2	17.2	2.2	100
LW012	12mm	12.2	20.2	2.5	50
LW014	14mm	14.2	23.2	3.0	25
LW016	16mm	16.2	26.2	3.5	25
LW018	18mm	18.2	28.2	3.5	25
LW020	20mm	20.2	32.2	4.0	25
LW024	24mm	24.5	40.0	5.0	25

MÉTRIQUE / METRIC

Assortiment de vis de mécanique

SDMS32



*Metal merchandiser with moulded compartments.
Size : 9-3/4" w x 13-3/4" l x 2" d.*

Square drive machine screw and nut Master assortment No. 020-624

- Contains 1120 pieces - 32 sizes, round and flat head and hexagon nuts.
- Metal box with moulded plastic compartments.
- Safety snap carrying handle.
- Actual size illustrations and retail price codes of every item shown on grease-resistant lid label.
- Refills available in standard packages of 100.

A practical assortment that gives complete coverage of all popular sizes of Machine Screws and Nuts.

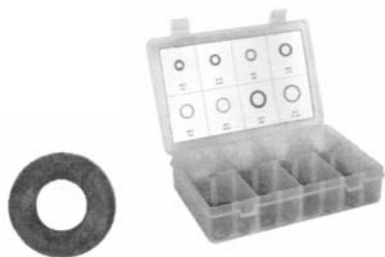

CWA240

Assortiment de rondelles de cuivre
Copper washer assortment

CWA240 Assortiment de rondelles de cuivre <i>Copper washer assortment</i>		Boîte box	Dim.
211-01	Rondelle de cuivre / <i>Copper washer</i>	50	1/4"
211-02	Rondelle de cuivre / <i>Copper washer</i>	40	5/16"
211-03	Rondelle de cuivre / <i>Copper washer</i>	30	3/8"
211-04	Rondelle de cuivre / <i>Copper washer</i>	30	7/16"
211-05	Rondelle de cuivre / <i>Copper washer</i>	30	1/2"
211-06	Rondelle de cuivre / <i>Copper washer</i>	20	.5625
211-07	Rondelle de cuivre / <i>Copper washer</i>	20	5/8"
211-08	Rondelle de cuivre / <i>Copper washer</i>	20	11/16"

Anneaux en cuivre / Copper washers



METRIC

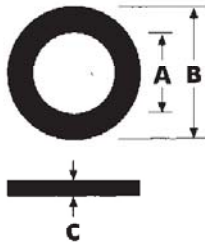

	A mm	B mm	C mm	6-14 mm		16-21 mm	22-30 mm
				S12278 Qty 90 S	S8921 Qty 400 S	S8922 Qty 240 S	S8923 Qty 120 S
S8829	5	9	1	-	-	-	-
S8830	6	10	1	10	50	-	-
S8831	6,5	9,5	1	-	-	-	-
S8832	8	12	1	10	50	-	-
S8833	8	14	1	-	50	-	-
S8834	10	14	1	-	50	-	-
S8835	10	16	1	10	-	-	-
S12279	10	20	2	-	-	-	-
S8836	12	16	1,5	-	50	-	-
S8837	12	18	1,5	10	50	-	-
S8838	14	18	1,5	-	50	-	-
S8839	14	20	1,5	10	50	-	-
S8840	16	20	1,5	-	-	30	-
S8841	16	22	1,5	-	-	30	-
S8842	17	21	1,5	-	-	30	-
S8843	18	22	1,5	-	-	30	-
S8844	18	24	1,5	10	-	30	-
S8845	20	24	1,5	-	-	30	-
S8846	20	26	1,5	10	-	30	-
S8847	21	26	1,5	-	-	30	-
S8848	22	27	1,5	-	-	-	15
S8849	22	29	1,5	-	-	-	15
S8850	24	29	2	-	-	-	15
S8851	26	31	2	10	-	-	15
S8852	26	34	2	-	-	-	15
S8853	27	32	2	-	-	-	15
S8854	28	33	2	-	-	-	15
S8855	30	36	2	10	-	-	15
S8856	32	38	2	-	-	-	-
S8857	33	39	2	-	-	-	-

INCH

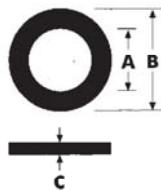

INCH

Anneaux en aluminium Aluminium washers



	Anneaux en cuivre / Copper washers				Qty 500 S
	Bolt o ins	A ins	B ins	C	
S6364	3/16"	1/4"	1/2"	20G	100
S6365	1/4"	17/64"	35/64"	20G	100
S6366	5/16"	11/32"	9/16"	20G	100
S11112	-	13/32"	11/16"	16G	-
S6367	3/8"	13/32"	11/16"	18G	50
S6368	7/16"	29/64"	29/32"	18G	30
S6369	1/2"	17/32"	27/32"	18G	30
S6370	9/16"	19/32"	61/64"	18G	30
S6371	-	0.395"	0.830"	14G	30
S6372	-	0.570"	0.820"	17G	30

S6371 replaces Perkins 0921173

S6372 replaces Perkins 0920113

	Anneaux en aluminium Aluminium washers				Qty 480 S
	Bolt o ins	A ins	B ins	C	
S11224	3/16"	1/4"	1/2"	20G	100
S11225	1/4"	17/64"	35/64"	20G	100
S11226	5/16"	11/32"	9/16"	20G	100
S11227	3/8"	13/32"	11/16"	18G	30
S11228	7/16"	29/64"	29/32"	18G	30
S11229	1/2"	17/32"	27/32"	18G	30
S11230	9/16"	19/32"	61/64"	18G	30
S11231	-	0.395"	0.830"	14G	30
S11232	-	0.570"	0.820"	17G	30
S11113	-	5/16"	7/16"	20G	-



VIS DE MÉCANIQUE PLAQUÉ STEEL MACHINE SCREWS-PLATED

DIA.	3/8	1/2	3/4	7/8	1"
	Numéros Numbers	Numéros Numbers	Numéros Numbers	Numéros Numbers	NUMÉROS NUMBERS
6-32	MS02	MS1	MS11		MS31
8-32		MS2	MS12		MS32
10-24	MS04	MS3	MS13		MS33
10-32		MS4	MS14		MS34
12-24		MS6	MS15		
1/4-20	MS16				
1/4-28					
5/16-18					
DIA.		1-1/4	1-1/2	ÉCROU	ÉCROUS HEXAGONAUX POUR VIS DE MÉCANIQUE STEEL MACHINE SCREW NUTS <i>Hexagon</i>
		Numéros Numbers	Numéros Numbers	Numéros Numbers	
6-32		MS41	MS52 MS54 MS56	MSN1	
8-32		MS42		MSN2	
10-32		MS44		MSN3	
12-24				MSN4	



VIS DE PRESSION À TÊTE CARRÉE SQUARE HEAD SET SCREWS

Numéros Numbers	Dimension	Filet Thread	Boîte Box
SQS1	1/4x1/2	UNC	100
SQS2	1/4x1	UNC	100
SQS3	5/16x1/2	UNC	100
SQS4	5/16x3/4	UNC	100
SQS5	5/16x1	UNC	100
SQS6	5/16x1-1/4	UNC	100
SQS7	3/8x3/4	UNC	100
SQS8	3/8x1	UNC	100
SQS9	3/8x1-1/4	UNC	100
SQS10	7/16x1	UNC	50
SQS11	7/16x1-1/2	UNC	50
SQS12	1/2x1	UNC	50
SQS13	1/2x1-1/4	UNC	50

SQSU66 Assortiment vis de pression à tête carrée 66 pièces / 10 grandeurs
 Square HD set screw utility assortment 66 parts / 10 sizes

**VIS DE PRESSION À PANS CREUX
SOCKET SET SCREWS**

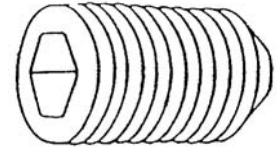

**Prix pour boîte de 100
Price for 100**

Numéros Numbers	Description	UNC
SOS1	10 x 3/16	24
SOS2	10 x 1/4	24
SOS3	10 x 5/16	24
SOS4	10 x 1/2	24
SOS5	1/4 x 1/4	20
SOS6	1/4 x 5/16	20
SOS7	1/4 x 3/8	20
SOS8	1/4 x 1/2	20
SOS10	5/16 x 5/16	18
SOS11	5/16 x 3/8	18
SOS12	5/16 x 1/2	18
SOS13	3/8 x 3/8	16
SOS14	3/8 x 1/2	16
SOS15	3/8 x 5/8	16
SOS19	1/2 x 1/2	13
Numéros Numbers	Description	UNF
SOS32	10 x 1/4	32
SOS33	10 x 5/16	32
SOS36	1/4 x 5/16	28
SOS37	1/4 x 3/8	28
SOS40	5/16 x 5/16	24



**UTILITY ASSORTMENT No: SSU19
Contains 120 Socket Set Screws, 12 Popular Sizes**

8-32 x 3/16	10 x 3/16	1/4-20 x 1/4
8-32 x 1/4	10-32 x 3/16	1/4-20 x 3/8
1/4-28 x 1/4	5/16-18 x 3/8	3/8-16 x 3/8
5/16-24 x 5/16	5/16-18 x 1/2	3/8-16 x 1/2

Packed in a sturdy fibre board container with a separate compartment for each size. Lid label is illustrated and shows retail prices.



**Assortiment de vis de pression à pans creux
Socket set screw assortment**

MM44 Assortiment comprenant 192 vis de pression à pans creux
(020-629)

“ **ROLLER NATIONAL COARSE THREAD** ”

ÉCROUS DE RACCORD
“ **HEX COUPLING NUTS** ”

TIGE FILETÉE - THREADED ROD

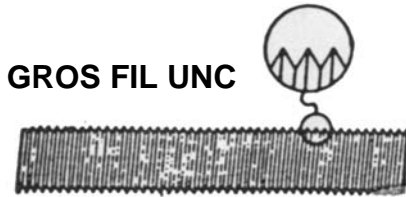

GROS FILET UNC
“ **UNC COARSE THREAD** ”

Tige Filetée Alloy Threaded Rod	Tige Filetée Standard Threaded Rod	Description	Qté Qty Tube Tube	Écrous raccord Coupling nuts	Description
RDYR1B7	RDYR1	1/4 UNC 36"	25	XCN1	1/4 UNC, 7/8 long
RDYR2B7	RDYR2	5/16 UNC 36"	20	XCN2	5/16 UNC, 1-3/4 long
RDYR3B7	RDYR3	3/8 UNC 36"	15	XCN3	3/8 UNC, 1-3/4 long
RDYR4B7	RDYR4	7/16 UNC 36"	10	XCN4	7/16 UNC, 1-3/4 long
RDYR5B7	RDYR5	1/2 UNC 36"	10	XCN5	1/2 UNC, 1-3/4 long
RDYR6B7	RDYR6	5/8 UNC 36"	5	XCN6	5/8 UNC, 2-1/8 long
RDYR7B7	RDYR7	3/4 UNC 36"	5	XCN7	3/4 UNC, 2-1/4 long
RDYR8B7	RDYR8	7/8 UNC 36"	3	XCN8	7/8 UNC, 2-1/2 long
RDYR9B7	RDYR9	1" UNC 36"	3	XCN9	1" UNC, 2-1/2 long

“ **ROLLER ACME THREADS** ”

ÉCROUS STANDARD
ACME
“ **STANDARD**
ACME
NUTS ”

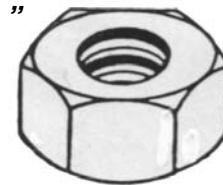
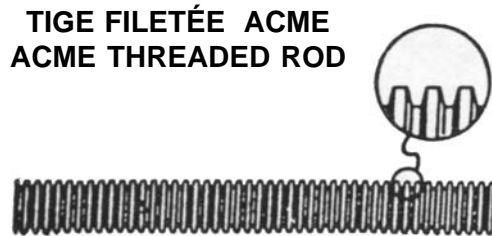

Tige Rod	Longueur std 12' Std length 12 ft	Écrous Nuts
ACMER2	3/8 - 12 filets au pouce (TPI)	ACMEN2
ACMER3	1/2 - 10 filets au pouce (TPI)	ACMEN3
ACMER4	5/8 - 8 filets au pouce (TPI)	ACMEN4
ACMER5	3/4 - 6 filets au pouce (TPI)	ACMEN5
ACMER6	7/8 - 6 filets au pouce (TPI)	ACMEN6
ACMER7	1" - 5 filets au pouce (TPI)	ACMEN7

Tige filetée - Thread rod



Numéros <i>Numbers</i>	Description
RDYRM3	Tige filetée mm 3 x 0,50 x 1 mètre <i>Thread rod mm 3 x 0,50 x 1 meter</i>
RDYRM4	Tige filetée mm 4 x 0,70 x 1 mètre <i>Thread rod mm 4 x 0,70 x 1 meter</i>
RDYRM5	Tige filetée mm 5 x 0,80 x 1 mètre <i>Thread rod mm 5 x 0,80 x 1 meter</i>
RDYRM6	Tige filetée mm 6 x 1,00 x 1 mètre <i>Thread rod mm 6 x 1,00 x 1 meter</i>
RDYRM7	Tige filetée mm 7 x 1,00 x 1 mètre <i>Thread rod mm 7 x 1,00 x 1 meter</i>
RDYRM8	Tige filetée mm 8 x 1,25 x 1 mètre <i>Thread rod mm 8 x 1,25 x 1 meter</i>
RDYRM10	Tige filetée mm 10 x 1,50 x 1 mètre <i>Thread rod mm 10 x 1,50 x 1 meter</i>
RDYRM12	Tige filetée mm 12 x 1,75 x 1 mètre <i>Thread rod mm 12 x 1,75 x 1 meter</i>
RDYRM14	Tige filetée mm 14 x 2,00 x 1 mètre <i>Thread rod mm 14 x 2,00 x 1 meter</i>
RDYRM16	Tige filetée mm 16 x 2,00 x 1 mètre <i>Thread rod mm 16 x 2,00 x 1 meter</i>
RDYRM18	Tige filetée mm 18 x 2,50 x 1 mètre <i>Thread rod mm 18 x 2,50 x 1 meter</i>
RDYRM20	Tige filetée mm 20 x 2,50 x 1 mètre <i>Thread rod mm 20 x 2,50 x 1 meter</i>

**Écrous hexagonaux de jonction - Coupling nuts full thread
(Hauteur 3 x d)**



Numéros <i>Numbers</i>	Description
XCNM5	Écrou 5mm x 0,80
XCNM6	Écrou 6mm x 1,00
XCNM8	Écrou 8mm x 1,25
XCNM10	Écrou 10mm x 1,50
XCNM12	Écrou 12mm x 1,75
XCNM14	Écrou 14mm x 2,00
XCNM16	Écrou 16mm x 2,00
XCNM20	Écrou 20mm x 2,50

CLÉ DEMI-LUNE

WOODRUFF KEYS



GOUILLE FENDUE EN ACIER

COTTER PINS

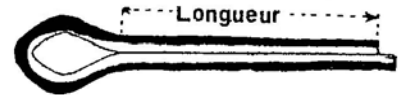

Numéros Numbers	Spécifications	Qté Boîte Qty Box	Numéros Numbers	Spécifications	Qté Boîte Qty Box
DL1-1	1/16 x 1/2	25	CP011	1/16 x 1/2	100
DL1-2	3/32 x 1/2	25	CP01	1/16 x 3/4	100
DL2-4	3/32 x 5/8	25	CP1	1/16 x 1	100
DL3-3	1/8 x 1/2	25	CP1A	1/16 x 1-1/4	100
DL4-5	1/8 x 5/8	25	CP2	1/16 x 1-1/2	100
DL5-6	5/32 x 5/8	25	CP2B	3/32 x 3/4	100
DL6-8	5/32 x 3/4	25	CP3	3/32 x 1	100
DL7-10	5/32 x 7/8	25	CP3A	1/8 x 3/4	100
DL8-9	3/16 x 3/4	25	CP4	3/32 x 1-1/2	100
DL9-11	3/16 x 7/8	25	CP5	3/32 x 2	100
DL10-13	3/16 x 1	25	CP5A	3/32 x 1-1/4	100
DL11-14	7/32 x 1	25	CP6	1/8 x 1	100
DL12-17	7/32 x 1-1/8	25	CP6A	1/8 x 1-1/4	100
DL13-20	7/32 x 1-1/4	25	CP7	1/8 x 1-1/2	100
DL14-91	1/4 x 3/4	25	CP7A	1/8 x 1-3/4	100
DL15A	1/4 x 7/8	25	CP8	1/8 x 2	100
DL16-15	1/4 x 1	25	CP9	1/8 x 2-1/2	100
DL17-21	1/4 x 1-1/4	25	CP10	5/32 x 1	100
DL18-22	1/4 x 1-3/8	25	CP11	5/32 x 1-1/2	100
DL19B	5/16 x 1	25	CP12	5/32 x 2	100
DL20D	5/16 x 1-1/4	25	CP13	5/32 x 2-1/2	100
DL21-23	5/16 x 1-3/8	25	CP14	3/16 x 1-1/2	100
DL22-25	5/16 x 1-1/2	25	CP14A	3/16 x 1	100
DL23-152	3/8 x 1	25	CP15	3/16 x 2	100
DL24E	3/8 x 1-1/4	25	CP16	3/16 x 2-1/2	100
DL25F	3/8 x 1-3/8	25	CP16A	3/16 x 3	100
DL26G	3/8 x 1-1/2	25	CP17	1/4 x 1-1/2	100
			CP18	1/4 x 2	100
			CP19	1/4 x 2-1/2	100
			CP19A	1/4 x 3	100
			CP20	5/16 x 1-1/2	100
			CP21	5/16 x 2	100
			CP22	5/16 x 2-1/2	100
			CP24	3/8 x 2	100
			CP25	3/8 x 2-1/2	100
			CP26	3/8 x 3	100



ASSORTIMENT DE CLÉ DEMI-LUNE



WOODRUFF KEY ASST

DLK9

Assortiment de clés demi-lune comprenant: 20 dimensions de 3/32 x 1/2" à 1/4" x 1-3/8".
Total: **210 pièces**

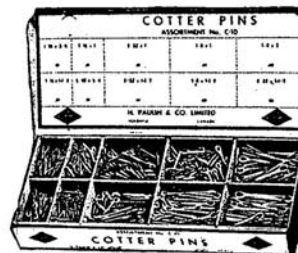

ASSORTIMENT DE GOUILLES FENDUES EN ACIER
COTTER PIN ASST

350-4 Assortiment comprenant: 900 goupilles fendues en acier de 1/16 x 3/4, 1, 1-1/2; 3/32 x 3/4, 1, 1-1/2; 1/8 x 1, 1-1/2, 2; 5/32 x 1-1/2

MM13 Assortiment dans une boîte de métal comprenant 1230 goupilles fendues en acier de 1/16 à 3/16.

CLÉS EN LONGUEUR MAK-A-KEY



Plaqué - Plated



Plaqué - Plated

Numéros Numbers	Description	Numéros Numbers	Description
MKS2	1/8" x 1/8" x - 12"	MKR2-3	1/8" x 3/16" - 12"
MKS3	3/16" x 3/16" - 12"	MKR2-4	1/8" x 1/4" - 12"
MKS4	1/4" x 1/4" - 12"	MKR3-4	3/16" x 1/4" - 12"
MKS5	5/16" x 5/16" - 12"	MKR4-5	1/4" x 5/16" - 12"
MKS6	3/8" x 3/8" - 12"	MKR4-6	1/4" x 3/8" - 12"
MKS7	7/16" x 7/16" x 12"	MKR5-6	5/16" x 3/8" - 12"
MKS8	1/2" x 1/2" - 12"	MKR6-7	3/8" x 7/16" - 12"
MKS10	5/8" x 5/8" - 12"	MKR7-8	7/16" x 1/2" - 12"
MKS12	3/4" x 3/4" - 12"	MKR8-10	1/2" x 5/8" - 12"



MKA30

Assortiment de clés en longueur *Mak-a-Key* Plaqué - Plated

Assortiment dans une boîte de carton-fibre
comprenant 31 clés carrées de 12" de long soit:

5 de 1/8"	5 de 3/16"	5 de 1/4"
5 de 5/16"	5 de 3/8"	3 de 7/16"
3 de 1/2"	(T-P)	

NON PLAQUÉ - UNPLATED
12" LONG

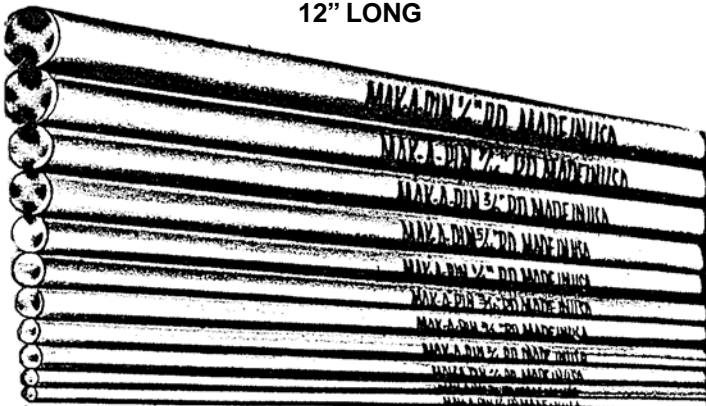

MP4
MP6
MP8
MP10
MP11
MP14
MP16
MP18
MP20
MP24

Goupilles en longueur *Mak-a-Pin*

1/8 rond, 12" long
3/16 rond, 12" long
1/4 rond, 12" long
5/16 rond, 12" long
3/8 rond, 12" long
7/16 rond, 12" long
1/2 rond, 12" long
9/16 rond, 12" long
5/8 rond, 12" long
3/4 rond, 12" long

CES "KITS" SONT DANS DES BOÎTES DE PLASTIQUE NOIR
THESE KITS ARE PACKED IN BLACK PLASTIC BOXES

**Woodruff
Keys
DIN 6888**



METRIC

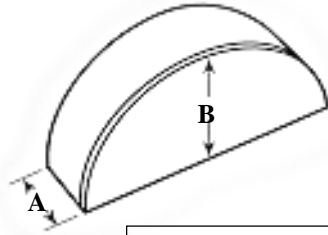

	A mm	x	B mm	Qty 95 ▲
S. 11057	3	x	5	10
S. 11058	4	x	5	10
S. 11059	4	x	6.5	10
S. 11060	5	x	9	10
S. 11061	6	x	9	10
S. 11062	6	x	10	10
S. 11063	6	x	11	10
S. 11064	8	x	11	10
S. 11065	8	x	13	5
S. 11066	10	x	11	5
S. 11067	10	x	13	5

**Circlips
DIN 6799**



METRIC



	ø mm	Gø mm	Qty 500 ▲
S. 11902	6	4.0	100
S. 11903	7	5.0	100
S. 11904	8	6.0	100
S. 11905	9.5	7.0	50
S. 11906	10.5	8.0	50
S. 11907	12	9.0	40
S. 11908	13	10.0	30
S. 11909	15.5	12.0	30
S. 14403	31.0	24.0	-

**Hexagon Socket
Screws**



METRIC

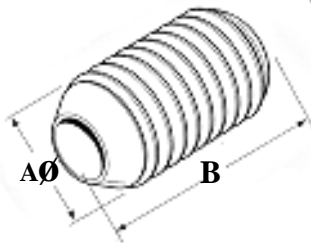

	Aø mm	x	B mm	Qty 220 ▲
S. 2926	4	x	6	20
S. 2927	4	x	12	20
S. 2928	5	x	10	20
S. 2929	5	x	16	20
S. 2930	6	x	12	20
S. 2931	6	x	20	20
S. 2932	8	x	12	20
S. 2933	8	x	16	20
S. 2934	8	x	20	20
S. 2935	10	x	12	10
S. 2936	10	x	20	10
S. 2937	12	x	12	10
S. 2938	12	x	20	10

Key Steel



METRIC

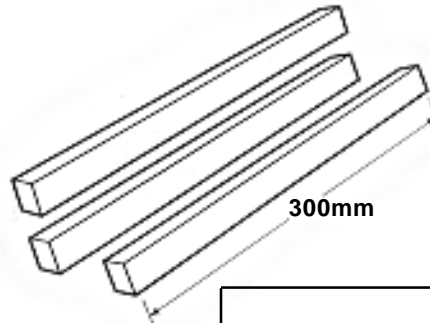

S. 3490

	mm	x	mm	Qty 9 ▲
S. 3481	4	x	4	1
S. 3482	5	x	5	1
S. 3483	6	x	6	1
S. 3484	8	x	7	1
S. 3485	10	x	8	1
S. 8394	12	x	10	
S. 3486	12	x	12	1
S. 3487	14	x	14	1
S. 3488	16	x	16	1

Ces Barres Viennent Enveloppées Dans Un Plastique
 These Key Steel come Wrapped in A Bundle.

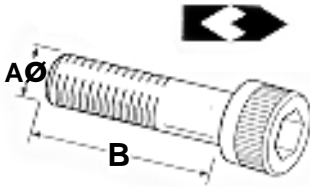
**Cap Head
Socket Screws
DIN 912**
UNC

S. 11836
**Qty
100**

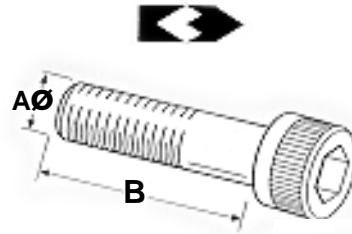
		ins		
		AØ	B	▲
S. 11666	No. 10	3/16"	x 1/2"	-
S. 11667	No. 10	3/16"	x 3/4"	20
S. 11668		1/4"	x 1/2"	-
S. 11669		1/4"	x 3/4"	20
S. 11670		1/4"	x 1"	-
S. 11671		5/16"	x 3/4"	-
S. 11672		5/16"	x 1"	20
S. 11673		5/16"	x 1-1/2"	-
S. 11674		5/16"	x 2"	10
S. 11675		5/16"	x 2-1/2"	-
S. 11676		3/8"	x 3/4"	-
S. 11677		3/8"	x 1"	-
S. 11678		3/8"	x 1-1/2"	10
S. 11679		3/8"	x 2"	-
S. 11680		3/8"	x 2-1/2"	10
S. 11681		3/8"	x 3"	-
S. 11682		1/2"	x 1-1/2"	5
S. 11683		1/2"	x 2"	-
S. 11684		1/2"	x 3"	5

**Cap Head
Socket Screws
DIN 912**
METRIC

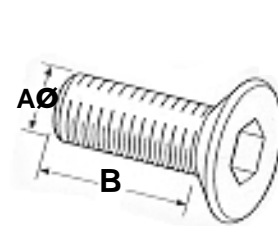
S. 11837
**Qty
160**

		mm		
		AØ	B	▲
S. 11643		3	x 12	-
S. 11644		4	x 12	-
S. 11645		4	x 16	-
S. 11646		5	x 10	20
S. 11647		5	x 16	20
S. 11648		5	x 25	20
S. 11741		6	x 10	-
S. 11649		6	x 12	-
S. 11650		6	x 16	20
S. 11651		6	x 20	20
S. 11730		6	x 25	20
S. 11652		6	x 30	20
S. 11731		6	x 50	-
S. 11653		8	x 12	-
S. 11654		8	x 16	20
S. 11655		8	x 20	-
S. 11732		8	x 25	-
S. 11656		8	x 30	-
S. 11657		8	x 40	-
S. 53897		8	x 45	-
S. 11658		8	x 50	-
S. 11659		8	x 70	-
S. 11776		10	x 16	-
S. 11660		10	x 20	-
S. 11661		10	x 25	-
S. 11662		10	x 30	-
S. 11733		10	x 35	-
S. 11734		10	x 40	-
S. 11735		10	x 60	-
S. 11736		12	x 20	-
S. 11663		12	x 25	-
S. 11737		12	x 30	-
S. 11738		12	x 35	-
S. 11739		12	x 40	-
S. 11664		12	x 45	-
S. 11740		12	x 50	-
S. 11703		12	x 60	-
S. 11665		12	x 80	-

**Hexagon Socket
Countersunk
Screws
DIN 7791 Grade 8.8**
METRIC

S. 11839

		mm		
		AØ	B	▲
S. 11795		6	x 10	-
S. 11796		6	x 16	-
S. 11797		6	x 25	10
S. 11798		6	x 30	10
S. 11799		8	x 16	-
S. 11800		8	x 20	20
S. 11801		8	x 25	20
S. 11802		8	x 30	20
S. 11803		8	x 40	10
S. 11804		10	x 16	-
S. 11805		10	x 20	-
S. 11806		10	x 25	-
S. 11807		10	x 30	10
S. 11808		10	x 35	10
S. 11809		10	x 40	-
S. 11810		10	x 60	-
S. 11811		12	x 20	-
S. 11812		12	x 25	-
S. 11813		12	x 30	-
S. 11814		12	x 35	-
S. 11815		12	x 40	-



**Vis tête fraisée
Hexagon socket head
Countersunk screw**

HX245

 Vis à tête fraisée 1/2" -
13 x 2-1/2"

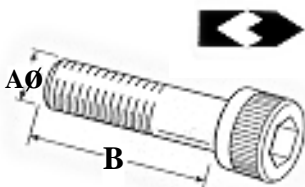
 Hexagon socket head
countersunk screw 1/2" -
13 x 2-1/2"

UNF

S. 11835
**Qty
100**

		ins		
		AØ	B	▲
S. 11685	No. 10	3/16"	x 1/2"	-
S. 11686	No. 10	3/16"	x 3/4"	20
S. 11687		1/4"	x 1/2"	-
S. 11688		1/4"	x 3/4"	20
S. 11689		1/4"	x 1"	20
S. 11690		5/16"	x 3/4"	-
S. 11691		5/16"	x 1"	10
S. 11692		5/16"	x 1-1/2"	10
S. 11704		5/16"	x 2"	10
S. 11693		5/16"	x 2-1/2"	-
S. 11694		3/8"	x 3/4"	-
S. 11695		3/8"	x 1"	-
S. 11696		3/8"	x 1-1/2"	5
S. 11697		3/8"	x 2"	-
S. 11698		3/8"	x 2-1/2"	5
S. 11699		3/8"	x 3"	-
S. 11700		1/2"	x 1-1/2"	-
S. 11701		1/2"	x 2"	-
S. 11702		1/2"	x 3"	-

Clés en longueur / key steel

ILLUSTRATIONS	NUMÉROS NUMBERS	DESCRIPTION
	S3481	4 mm x 4 mm x 300
	S3482	5 mm x 5 mm x 300
	S3483	6 mm x 6 mm x 300
	S3484	7 mm x 8 mm x 300
	S3537	8 mm x 8 mm x 300
	S3485	8 mm x 10 mm x 300
	S3538	10 mm x 10 mm x 300
	S8394	10 mm x 12 mm x 300
	S3486	12 mm x 12 mm x 300
	S3487	14 mm x 14 mm x 300
	S3488	16 mm x 16 mm x 300
	S3489	18 mm x 18 mm x 300

Goupilles fendues en acier (paquet) / Cotter pin pack

Illustrations	Numéros Numbers	Description		
	S2220 (VLF3602)	Assortiment de goupilles fendues (pqt 50) <i>Cotter pin (pkg 50)</i>		
		S2220	Qty	
		50	◆	
		S1497	A Ømm B	A Ø " B
		S1500	2.5 x 38	3/32" x 1-1/2"
		S1501	3.2 x 38	1/8" x 1-1/2"
		S1503	4 x 38	5/32" x 1-1/2"
		S1507	5 x 50	3/16" x 2"
		S1510	6.3 x 75	1/4" x 3"
		S1516	8 x 75	5/16" x 3"
S1516	2 x 38	1/16" x 1-1/2"		

**NOUVEAU
NEW**

L'ultime trousse de pointes pour tournevis (35 morceaux)

Ultimate ratchet screwdriver bit kit (35 pieces)

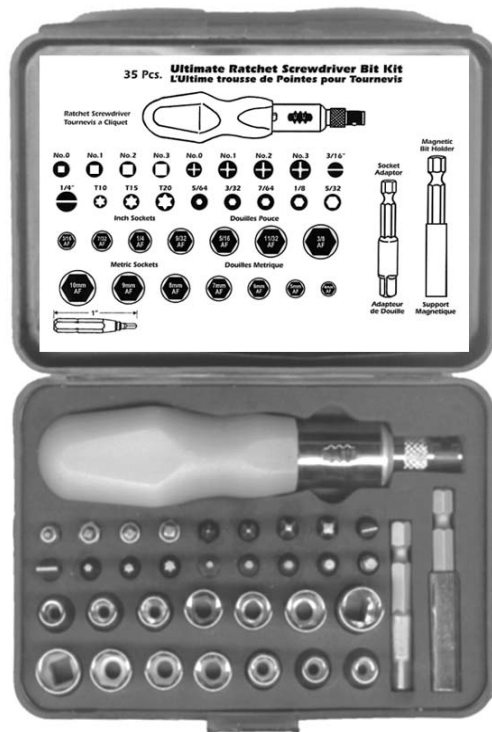

NUMÉRO NUMBER	DESCRIPTION	
<p>920-35</p>	<p>Trousse de pointes pour tournevis (35 morceaux) <i>Ratchet screwdriver bit kit (35 pieces)</i></p> <div style="border: 1px solid black; padding: 5px; text-align: center;"> <p>Voir la description à la page 17 See page 17 for description</p> </div>	

L'ultime trousse de pointes pour tournevis (35 morceaux)

Ultimate ratchet screwdriver bit kit (35 pieces)

Morneau & Thibodeau

920-35

L'ultime trousse de pointes pour tournevis
Ultimate ratchet screwdriver bit kit

35 pièces
35 pieces

Magnetic
Bit Holder

Support
Magnétique

Socket
Adaptor

Adapteur
de Douille

No. 0	No. 1	No. 2	No. 3	No. 0	No. 1	No. 2	No. 3	3/16"
1/4"	T10	T15	T20	5/64	3/32	7/64	1/8	5/32

Douilles Pouces / Inch Sockets

Douilles Métriques / Metric Sockets

1720, boul. de la Rive-sud, C.P. 2100
Saint-Romuald, Québec, G6W 5M3 Tél. (418) 839-4127

Storage Bins Heavy-Duty

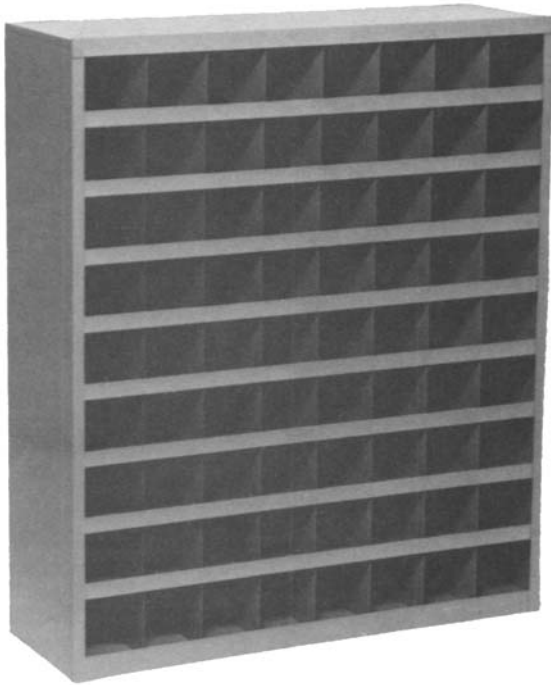

The perfect answer to storing bulk fasteners and offering these long-life features:

- *Extremely rigid construction as a result of a combination of interlocking and welded construction.*
- *Will not warp, twist or sag out of alignment.*
- *Fully hemmed lips on each bin keep parts securely in place and eliminate the possibility of spillage. No cut fingers.*
- *Available in blue baked enamel finish.*
- *Pressure sensitive bin labels are available.*
- *Individually packed in shipping carton.*

3 SIZES TO CHOOSE FROM SPECIFICATIONS

Numéros Numbers	Comp No	Width	Height	Depth	Bin Size	No. of bins	Weight
72B *	429-072	35-1/4"	42"	12"	4 x 4-1/2 x 12"	72	80 lbs
56B	429-056	35-1/4"	42"	12"	4-13/16 x 5-1/16 x 12"	56	75 lbs
42B	429-042	35-1/4"	42"	12"	5-3/8 x 5-7/16 x 12"	42	71 lbs

* Label set available - Order no. 429-172